

ROUGH COUNTRY

SUSPENSION SYSTEMS® 557INSTRBAG1

2015-19 F-150 4" & 6" LIFT KIT

THANK YOU FOR CHOOSING ROUGH COUNTRY FOR YOUR SUSPENSION NEEDS.

Rough Country recommends a certified technician install this system. In addition to these instructions, professional knowledge of disassemble/reassembly procedures as well as post installation checks must be known. Attempts to install this system without this knowledge and expertise may jeopardize the integrity and/or operating safety of the vehicle.

Please read instructions before beginning installation. Check the kit hardware against the parts list. Be sure you have all needed parts and know where they go. Also please review tools needed list and make sure you have needed tools.

PRODUCT USE INFORMATION

▲ WARNING The taller a vehicle is, the easier it will roll. We strongly recommend, because of rollover possibility that seat belts and shoulder harnesses should be worn at all times. Avoid situations where a side rollover may occur.

▲ WARNING Generally, braking performance and capability are decreased when larger/heavier tires and wheels are used. Take this into consideration while driving. Do not add, alter, or fabricate any factory or after-market parts to increase vehicle height over the intended height of the Rough Country product purchased. Mixing component brands is not recommended.

Rough Country makes no claims regarding lifting devices and excludes any and all implied claims. We will not be responsible for any product that is altered. If questions exist we will be happy to answer them concerning the design, function, and correct use of our products.

The 6" suspension system was developed using a 35X12.50/18 tire with 18 x 9 wheel with 4 1/2" backspace. The lifts were designed to lift the front to level the vehicle. Due to manufacturing, dimension variances, and inflation all tire and wheel combinations should be tested prior to installation on all oversized / wider then stock tires. We recommend using a 18" minimum wheel with corresponding tire, 9" in width with a minimum backspacing of 4.5" to a maximum of 5". When using a stock wheel, it must be 18" or larger and the maximum tire width is 11 1/2".

▲ NOTICE Vehicles will require the EPAS (Electronic Power Assist Steering) plugs to be disconnected prior to beginning installation of this kit. See installation instructions. Failure to disconnect these plugs may result in damage to the EPAS module resulting in an error message being displayed, which will require replacement of the EPAS module

▲ NOTICE DEALER AND VEHICLE OWNER

Any vehicle equipped with any Rough Country product should have a "Warning to Driver" decal installed on the inside of the windshield or on the vehicle's dash. The decal should act as a constant reminder for whoever is operating the vehicle of its unique handling characteristics.

Tools Needed:

5mm Allen Wrench	Floor Jack
8mm Allen Wrench	Jack stands
8mm wrench /socket	Reciprocating Saw
10mm wrench /socket	Hammer
12mm Wrench	9/16 wrench /socket
13mm wrench / socket	1 1/16" Wrench
15mm wrench /socket	Drill
16mm wrench /socket	1/4" Drill Bit
18mm wrench /socket	5/8" Drill Bit
19mm wrench /socket	11/32" Drill Bit
21mm wrench /socket	Torque Wrench
22mm wrench /socket	
24mm wrench /socket	
30mm wrench /socket	

Torque Specs:

Size	Grade 5	Grade 8
5/16"	15 ft/lbs	20 ft/lbs
3/8"	30 ft/lbs	35 ft/lbs
7/16"	45 ft/lbs	60 ft/lbs
1/2"	65 ft/lbs	90 ft/lbs
9/16"	95 ft/lbs	130 ft/lbs
5/8"	135 ft/lbs	175 ft/lbs
3/4"	185 ft/lbs	280 ft/lbs
	Class 8.8	Class 10.9
6MM	5 ft/lbs	9 ft/lbs
8MM	18ft/lbs	23 ft/lbs
10MM	32ft/lbs	45ft/lbs
12MM	55ft/lbs	75ft/lbs
14MM	85ft/lbs	120ft/lbs



4" KIT CONTENTS

55530 (4" Kit w/ N3 Shocks):

555BOX1
557BOX2
555BOX3
1555BOX4
1553BOX6
20165 x 2

55531 (4" Kit w/ N3 Struts & N3 Rr Shocks):

555BOX1
557BOX2
1555BOX4
1553BOX6
23033
20165 x 2

55570 (4" Kit w/ V2 Rr Shocks):

555BOX1
557BOX2
1555BOX4
1553BOX6
555BOX3
760751

55571 (4" Kit w/ N3 Struts & V2 Rr Shocks):

555BOX1
557BOX2
1555BOX4
1553BOX6
23033
760751

6" KIT CONTENTS

55730 (6" Kit w/ N3 Rr Shocks):

557BOX1
557BOX2
557BOX3
1555BOX4
1553BOX6

55731 (6" Kit w/ N3 Struts & N3 Rr Shocks):

557BOX1
557BOX2
1555BOX4
1553BOX6
649052 x 2
20165 x 2

55750 (6" Kit w/ Fr & RR Vertex Shocks):

557BOX1
557BOX2
1555BOX4
1553BOX6
680004
680005
690002 x 2

55770 (6" Kit w/ V2 Rr Shocks):

557BOX1
557BOX2
1555BOX4
1553BOX6
557BOX4
760751

55771 (6" Kit w/ N3 Struts & V2 Rr Shocks):

557BOX1
557BOX2
1555BOX4
1553BOX6
649052 x 2
760751

55757 (6" Kit w/ Vertex Coil overs & V2 Rr Shocks):

557BOX1
557BOX2
1555BOX4
1553BOX6
680004
680005
760751



KIT CONTENTS

1553Box6:

- 1-Driver Side Knuckle
- 1-Pass Side Knuckle

1555Box4:

- 1-Fr Crossmember
- 1-Rr Crossmember

557Box2:

- 1-Front Pass Diff Bracket
- 1-Dr Rear Diff Mount
- 2-Dr & Pass Diff Bracket
- 1-Pass Side Diff Brace Bracket
- 1-Dr Side Sway Bar Bracket
- 1-Pass Side Sway Bar Bracket
- 2-Fr Brake Line Brackets
- 1-Front Lower Skid Plate
- 1-Rear E-Brake Bracket
- 1-Front Driveshaft Spacer
- 1-Rear Brake Line Bracket
- 2-Rear Bump Stop Brackets (6" Kit)
- 1-1556Bag2
- 1-1557Bag8
- 1-1557Bag13
- 1-1557Bag15
- 1-557INSTRBAG
- 2-Cable Ties
- 1-1500

557Box1 (6" Kit Only):

- 2-Rear Blocks
- 1-1263Bag2
- 1-9/16Bag
- 4-9/16" x 3" x 13" Ubolts

555Box1 (4" Kit Only):

- 2-Rear Blocks
- 1-9/16Bag
- 4-9/16" x 3" x 11" Ubolts

557Box3 (55730 6" N3 Kit Only):

- 2-Strut Spacers
- 1-10mmstudbag
- 2-660751 Rear Shocks

555Box3 (4" Kit Only):

- 2-Strut Spacers
- 1-10mmstudbag

23033-4" Struts

649052-6" Struts

20165-Rear N3 Shocks

680004-Vertex Frt LH Coilover

680005-Vertex Frt RH Coilover

690002-Vertex Rear Shock

760751-Rear V2 Monotube Shock

1557Bag 8 Containing:

For Fr Dr Side Upper Diff Mount:

- 1-9/16" x 4" Bolt
- 2-9/16" Flat Washers
- 1-9/16" Lock Nut
- 1-1/2" x 1.5" Bolt
- 1-1/2" Nylock Nut
- 2-1/2" Flat Washer

For Fr Dr Side Lower Diff Mount:

- 1-9/16" x 4" bolt
- 2-9/16" Flat Washers
- 1-9/16" Lock Nut

For Fr / Rr Crossmember:

- 2-18mm x 150mm Bolts
- 4-3/4" Flat Washers
- 2-18mm Lock Nuts

For Fr Pass Side Diff Mount:

- 1-9/16" x 4" Bolt
- 2-9/16" Flat Washers
- 1-9/16" Lock Nut

1500 Containing:

For Lower Control Arms:

- 4-18mm x 160mm Cam Bolts
- 4-Flat Washers
- 4-18mm Lock Nuts

1557Bag15 Containing:

For Pass Diff Brace:

- 2-12mm x 35mm
- 2-12mm Lock Nut
- 4-Flat Washers

1557Bag13 Containing:

For Front Skid Plate:

- 4-3/8" x 1" Bolt
- 4-3/8" Flat Washers
- 2-3/8" Nylock Nuts

For Front Driveshaft:

- 6-10mm x 85mm Allen Bolts

For Front Brake Line Bracket:

- 2-5/16" x 3/4" Bolt
- 2-5/16" Flat Washer
- 2-5/16" Lock Nut

For Sway Bar Brackets:

- 4-7/16" x 1.25" Bolts
- 8-7/16" Flat Washers
- 4-Lock Nuts

For Diff Tube:

- 1-Diff Tube Ext.
- 1-Tube Coupler

For Rear Brake Line Brkt:

- 1-3/8" x 1" Bolt
- 2-3/8" Flat Washers
- 1-3/8" Lock Nut

For Rear E-brake Bracket:

- 1-5/16" x 3/4" Bolt
- 2-5/16" Flat Washers
- 1-5/16" Lock Nut

10mmStudBag Containing:

For Front Strut Spacers:

- 6-10mm Studs
- 6-10mm Lock Washer
- 7-10mm Hex Nuts
- 1-1/2" Jam Nut
- 6-3/8" Flat Washers

9/16Bag:

For Rear Blocks:

- 8-9/16" Nuts
- 8-9/16" Flat Washers

1263Bag2 (6" Kits Only):

For Rear Blocks:

- 4-7/16" UBolts
- 8-7/16" Nylock Nuts
- 8-7/16" Flat Washers

1556Bag2:

For Rear Blocks:

- 2-3/8" UBolts
- 4-3/8" Nylock Nuts



INSTALLATION INSTRUCTIONS

1. Chock the rear wheels and jack up the front of the vehicle.
2. Place jack stands under the frame rails and lower onto jack stands.
3. Remove the wheels/tires using a 21mm socket.
4. Remove the skid plate with a 13mm socket. **See Photo 1.**
5. Remove the EPAS (Electronic Power Assist Steering) Plugs as shown located on the steering assembly by the front differential. **See Photo 2. This must be done BEFORE installation is started.**



PHOTO 1

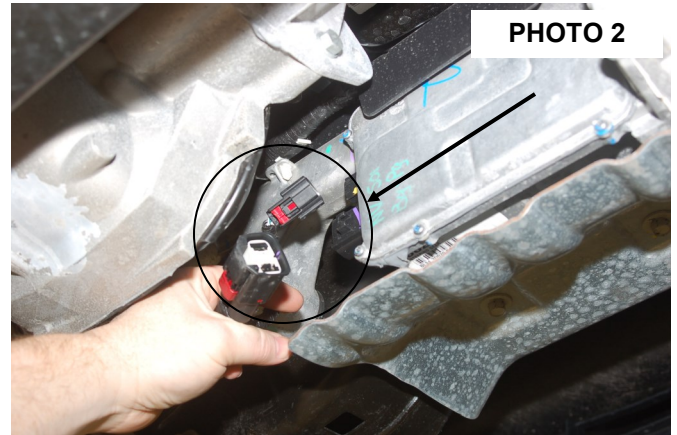

PHOTO 2

6. Remove tie-rod end using a 21mm wrench. Using the appropriate tool remove the tie-rod from the knuckle. **Photo 3.**
7. Remove the ABS and brake line bracket from the knuckle using a 8mm wrench for the ABS wire and a 10mm wrench for the brake line bracket. Retain hardware for reuse. **See Photo 4.**

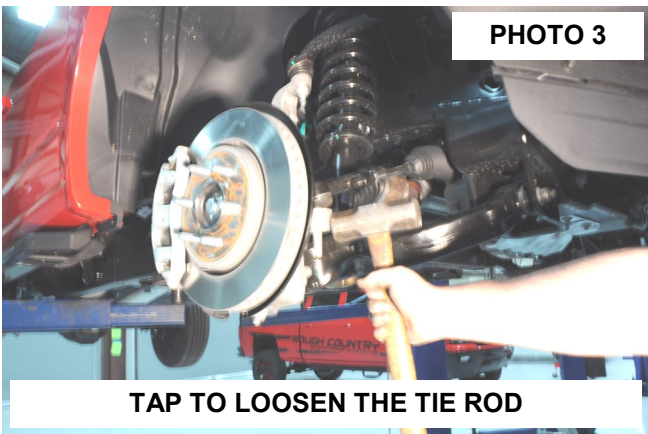

PHOTO 3

TAP TO LOOSEN THE TIE ROD

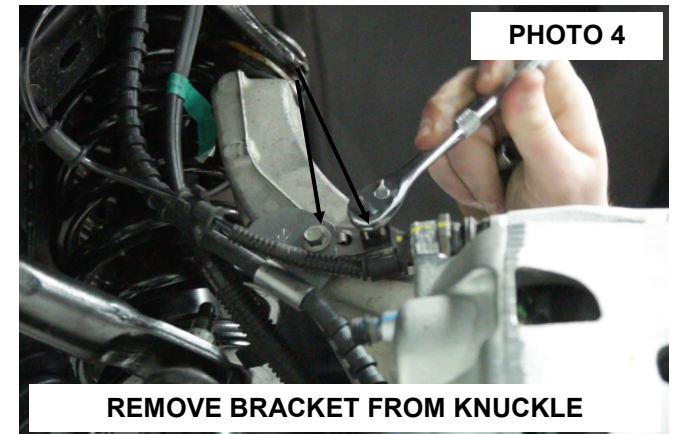

PHOTO 4

REMOVE BRACKET FROM KNUCKLE

8. Remove the vacuum line from the hub. **See Photo 5.**
9. Using a 19mm socket or 21mm socket, remove brake caliper as shown in **Photo 6.** Hang caliper out of way. Do not let caliper hang by brake hose as this will damage hose. Retain hardware for reuse. Remove rotor.



PHOTO 5

REMOVE VACUUM LINE FROM HUB

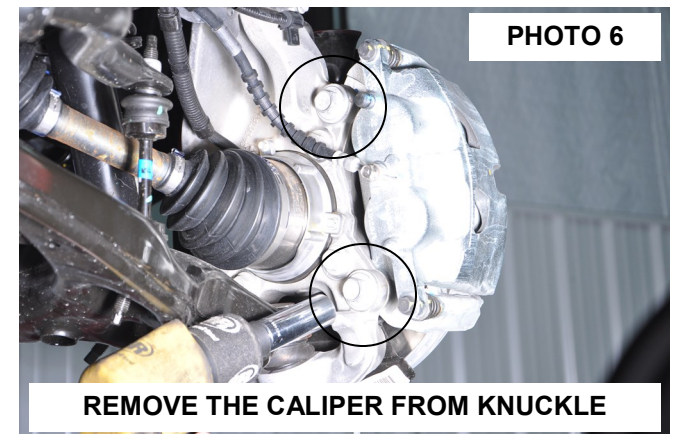
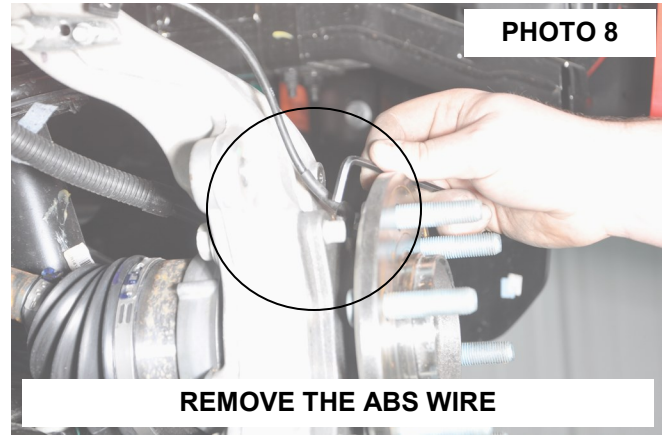
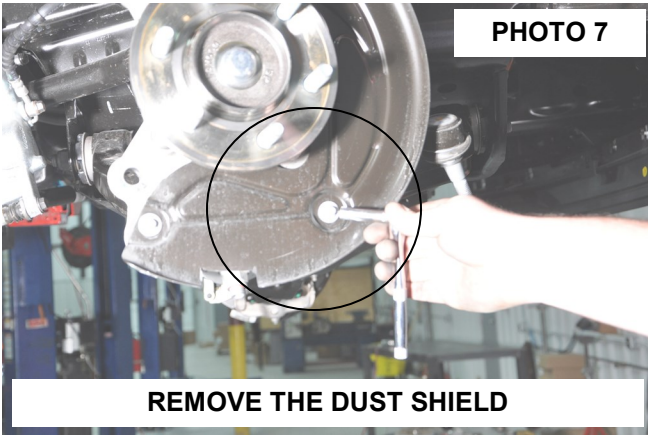

PHOTO 6

REMOVE THE CALIPER FROM KNUCKLE

10. Remove the dust shield using a 8mm socket and dust cap. **See Photo 7.**

11. Remove the ABS wire from the bearing assembly using a 5mm allen wrench. **See Photo 8.**



12. Remove the axle nut using a 15mm socket. Retain hardware for reuse. **See Photo 9.**

13. Loosen the upper ball joint nut using a 21mm wrench. Use the appropriate tool to release ball joint from knuckle. **See Photo 10.**

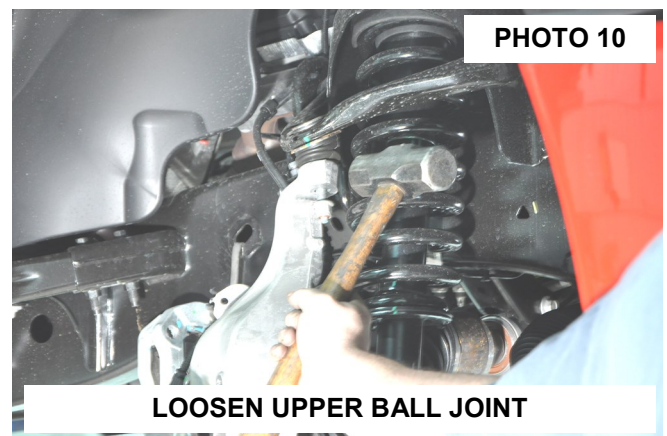
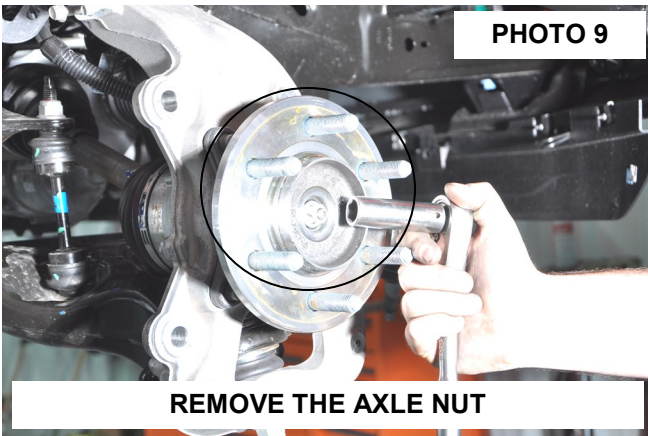

14. Loosen the lower ball joint using a 24mm wrench. Use the appropriate tool to release ball joint from knuckle. **See Photo 11.**

15. Remove the upper and lower ball joint nuts and remove the knuckle from the vehicle.

16. Remove the sway bar links from the sway bar using a 8mm and 19mm wrench. Retain hardware for reuse. **See Photo 12.**

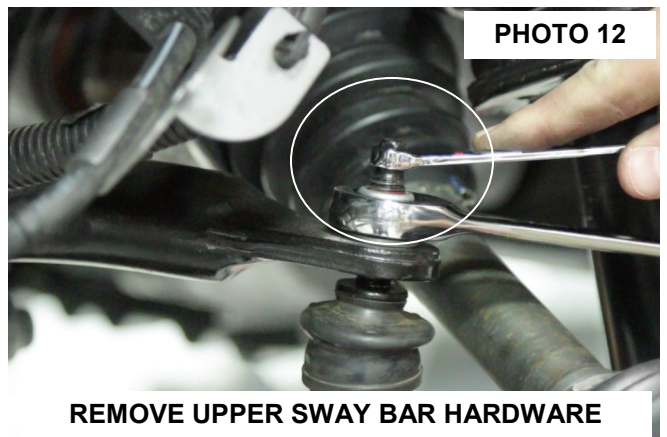
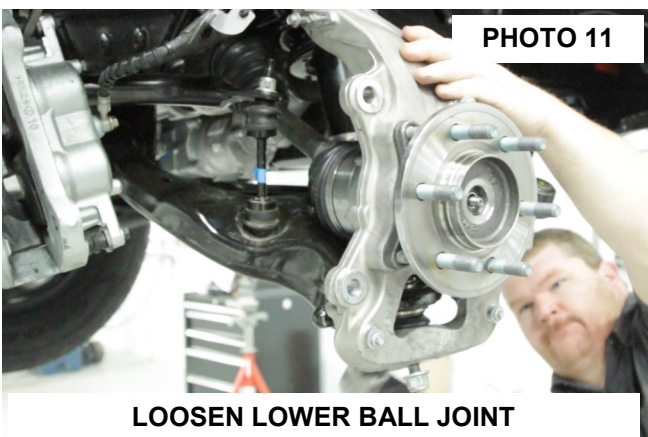

17. Remove the lower strut nuts using a 18mm socket. **See Photo 13.** Retain hardware for reuse.
18. Remove the sway bar from the frame mount using a 15mm socket. *Please note the position that the sway bar is installed from the factory to make sure it is reinstalled correctly.* Retain hardware for reuse. **See Photo 14.**

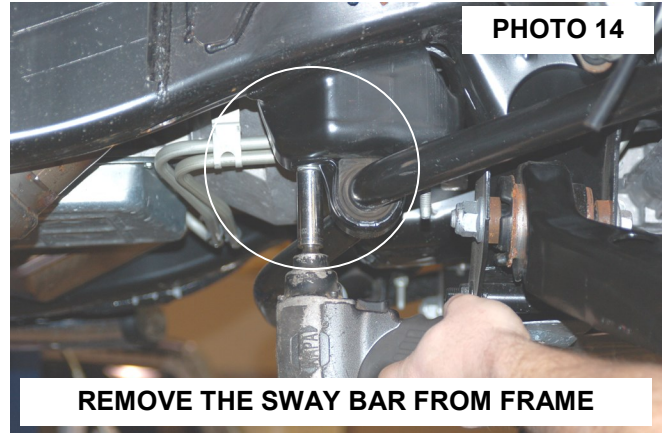
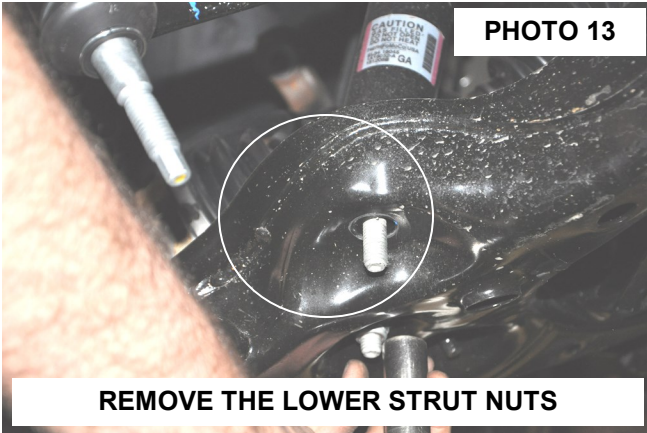

19. Remove the lower control arm using a 21mm and 1-1/16" wrench. Retain hardware for reuse. **See Photo 15.**
20. Remove the strut from the upper mount using a 15mm socket / wrench. Retain hardware for reuse. **See Photo 16.**

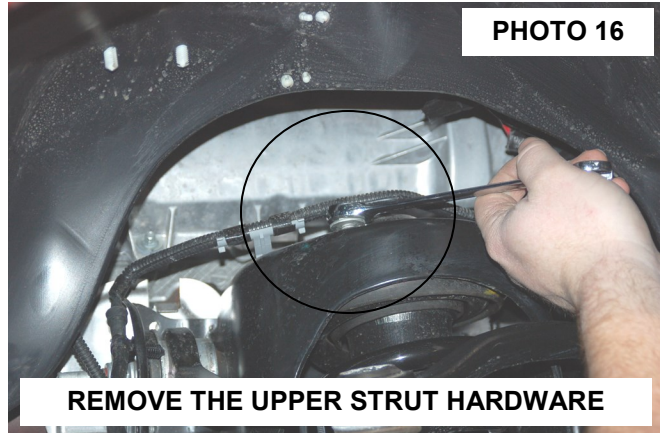
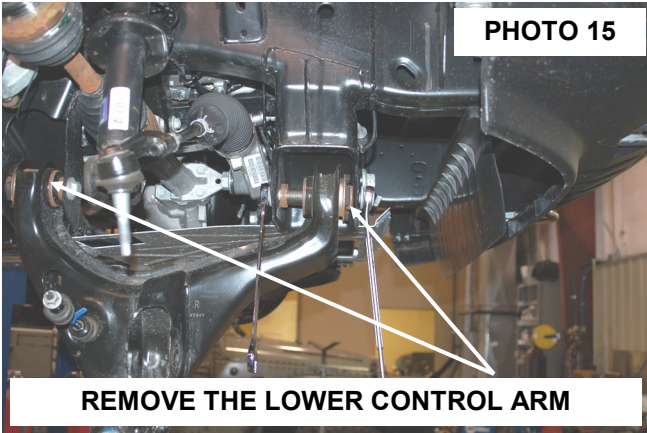

21. Remove the lower skid plate if equipped by removing the 4 bolts using a 13mm socket. **See Photo 17.**
22. Remove the driveshaft from the front differential using a 10mm socket. **See Photo 18.** Secure driveshaft out of the way.

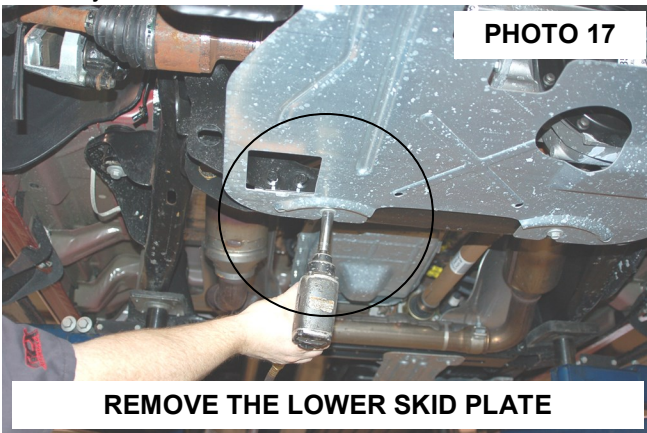

23. Remove the stock rear cross-member using a 15mm & 18mm socket. Retain hardware for reuse. **See Photo 19.**

▲ NOTICE 2018 Models will have to make rear crossmember mount cuts in steps 26-30 before removing the differential.

24. Support the differential using a floor jack and remove the upper driver side differential bolt using a 18mm wrench. Retain hardware for reuse. **See Photo 20.**

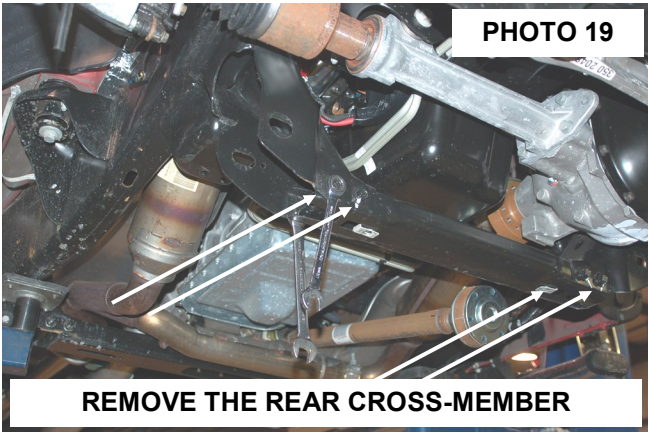

PHOTO 19

REMOVE THE REAR CROSS-MEMBER

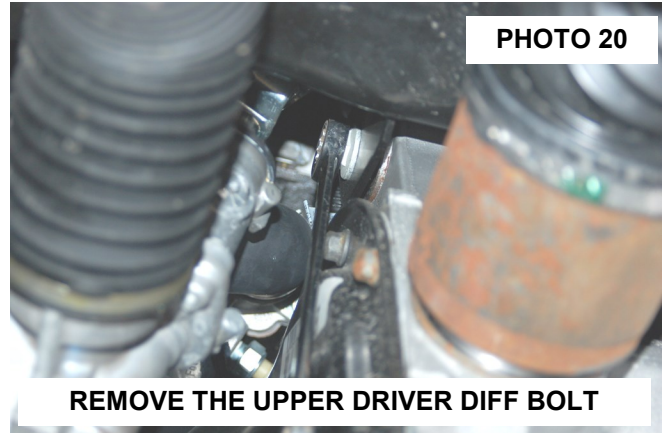

PHOTO 20

REMOVE THE UPPER DRIVER DIFF BOLT

25. Remove the differential vent tube from the differential.

26. Remove the passenger side differential bolt using a 18 & 21mm wrench. Retain hardware for reuse. **See Photo 21.**

27. Remove the lower rear driver side differential bolt using a 21mm socket / wrench. Lower and remove the differential from the vehicle. Tape supplied cutting template on front and back side of the driver side lower cross-member mount. Using template as a guide, trim cross-member mount to allow the differential to be removed. **See Photo 22.**

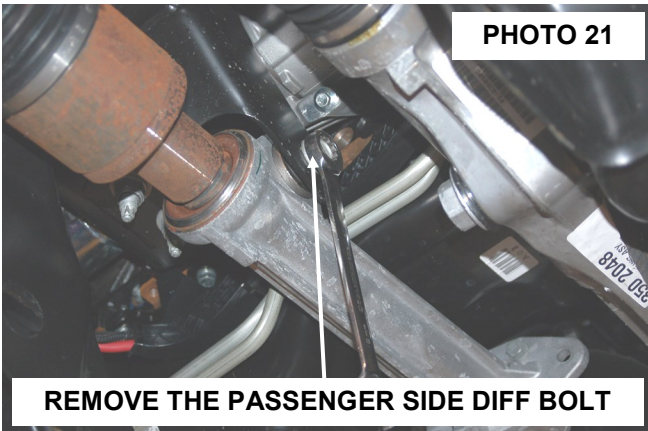

PHOTO 21

REMOVE THE PASSENGER SIDE DIFF BOLT

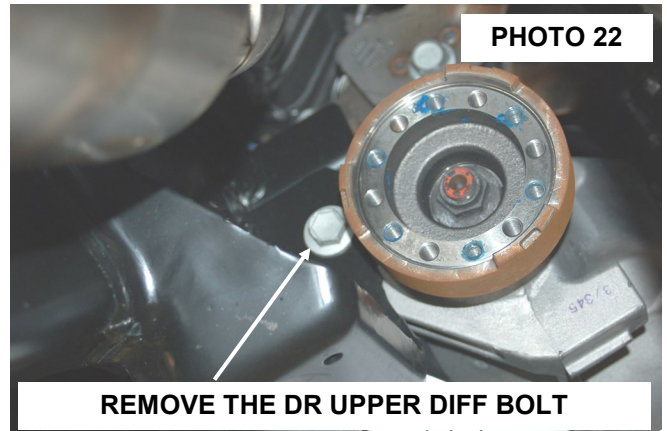

PHOTO 22

REMOVE THE DR UPPER DIFF BOLT

28. Tape supplied cutting template on front and back side of the driver side lower cross-member mount. Using template as a guide, trim cross-member mount to allow the differential to be removed. **See Photo 23.**

29. Complete the trimming of the frame on the driver side using the template. **See Photo 24.**

PHOTO 23



INSTALL THE TEMPLATES AND CUT

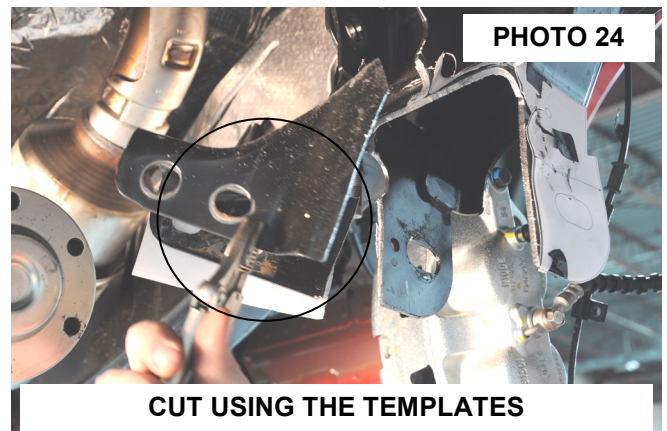
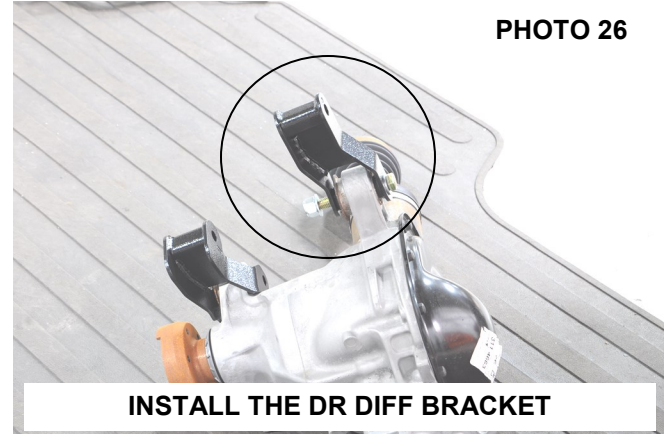
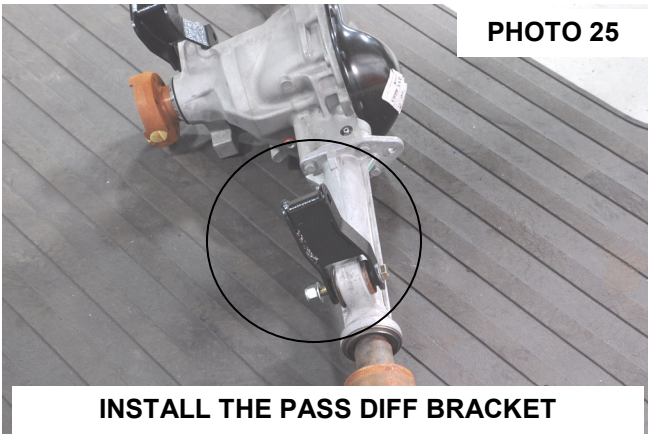

PHOTO 24

CUT USING THE TEMPLATES

30. Install the new bracket on the passenger side diff mount with the supplied hardware. Install the 9/16" x 4" bolt, washers & nut in the in the passenger side mount. Do not tighten at this time. **See Photo 25.**
31. Install the front driver side diff mount with the supplied 9/16" x 4" bolt, washers and nut **from the front to rear.**
NOTE: The differential mount bolts will need to be inserted from the front of the differential in order to clear the rack and pinion. Do not tighten at this time. See Photo 26.



32. Install the rear diff mount using the supplied 9/16" x 4" hardware. Do not tighten at this time. **See Photo 27.**
33. Raise the differential into place and install the upper differential bolts using the stock hardware. **See Photo 28.** Do not tighten at this time.

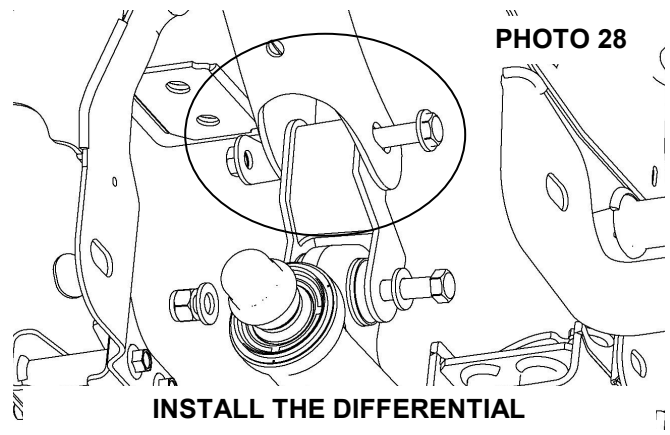
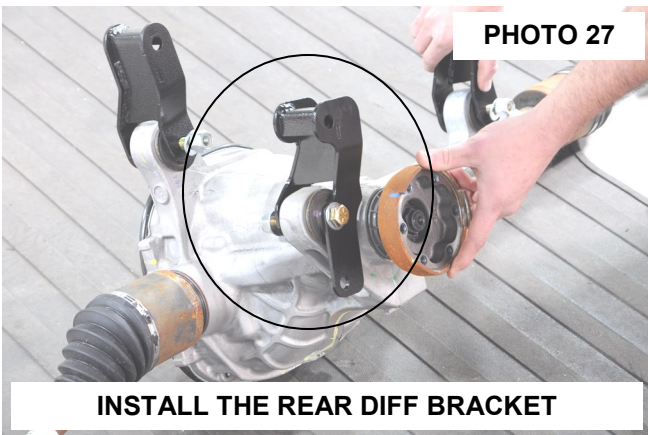

34. Install the sway bar drop brackets using factory hardware. **Do not tighten at this time.**
35. Install the rear cross-member with the supplied 18mm x150mm bolt. The bolt will install through the sway bar bracket and rear cross-member, securing it to the stock location. Do not tighten at this time. **See Photo 29.**
36. Install the passenger side differential brace as shown in **Photo 30** using the supplied 12mm hardware in 1557BAG15. Do not tighten at this time.

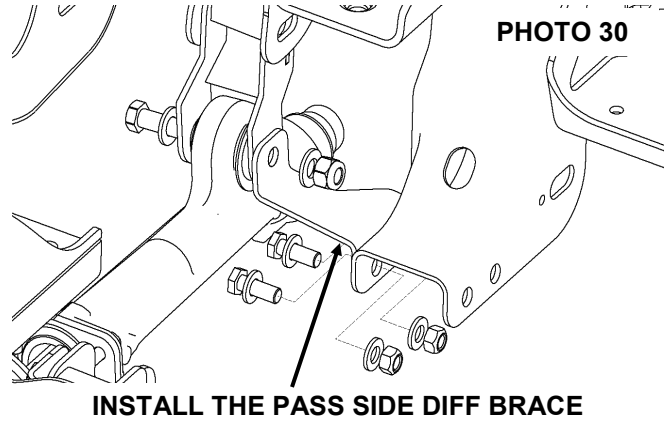
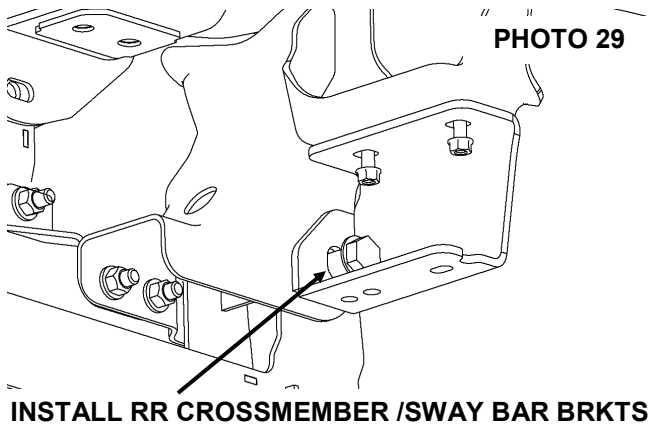

37. Install the rear drivers side diff mount. Use the factory bolt in the top mount and the supplied 1/2" hardware in the crossmember mount. Torque the factory bolt to 90ft-lbs and the 1/2" hardware to 90ft-lbs. **See Photo 31.**
38. Tighten the (3) 9/16" x4" differential bolts. Torque to 100ft/lbs with a 21mm socket and 22mm wrench. **See Photo 32.**
39. At this time tighten the (3) upper factory diff bolts. Torque to 90ft-lbs. using 18mm socket and wrench. Torque the lower 9/16" x4 hardware to 100ft/lbs using a 21mm & 22mm socket and wrench. Also torque the passenger side diff brace hardware to 55ft/lbs using a 19mm socket & 18mm wrench.

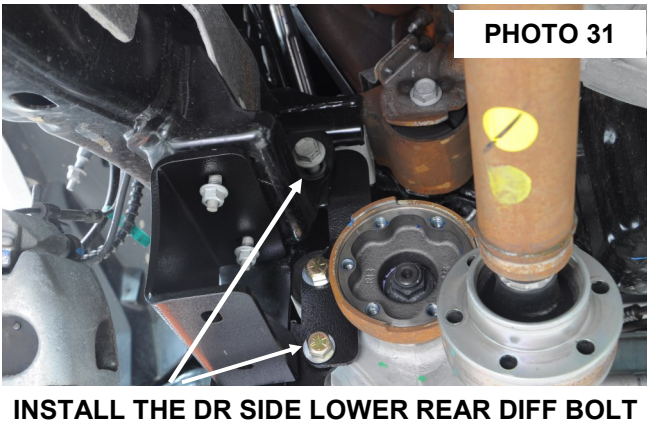

INSTALL THE DR SIDE LOWER REAR DIFF BOLT

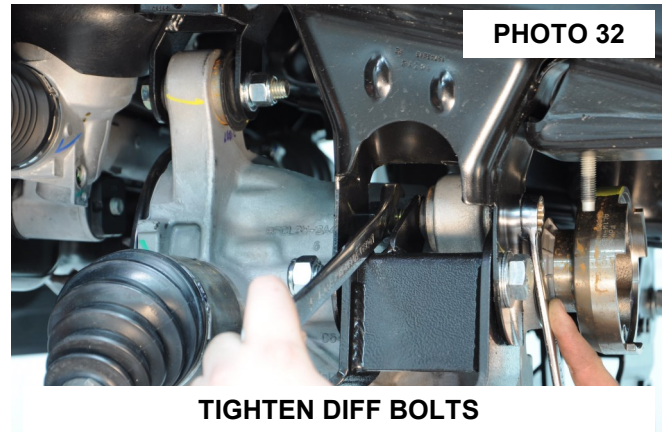

TIGHTEN DIFF BOLTS

40. Tighten the sway bar drop mounts to the frame. Torque nuts to 35ft-lbs. using a 15mm socket. **See Photo 33.**
41. Reinstall the vent tube on the differential with the new supplied vent tube extension 1557BAG13.
42. Install the front cross-member using the factory hardware. **See Photo 34.** Do not tighten at this time.

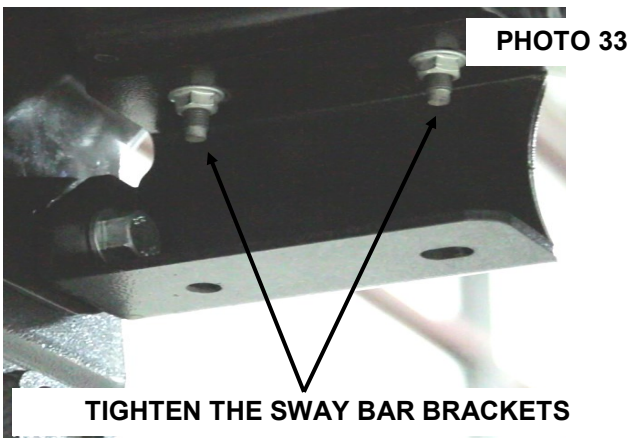

TIGHTEN THE SWAY BAR BRACKETS

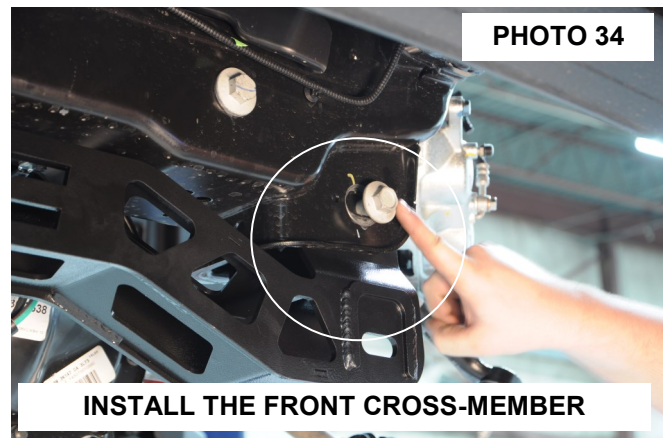

INSTALL THE FRONT CROSS-MEMBER

43. Install the lower control arms using the supplied 18mm x 160mm cam bolts, washers and nuts. **See Photo 35.** Do not tighten at this time.
44. Install the new skid plate in the rear cross member threaded holes using the supplied 3/8" x 1" bolts, washers. Attach to the front cross member using the supplied 3/8" x 1" bolts, washers and nylock nuts from 1557BAG13. **See Photo 36.** Torque using a 9/16" socket and wrench to 30ft-lbs.
45. Tighten all upper cross-member bolts. Torque to 190 ft-lbs using a 21mm, 1 1/16" socket and 1 1/16" wrench.

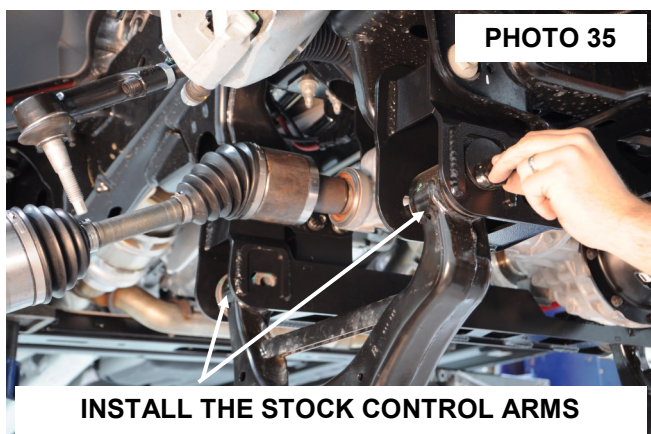

INSTALL THE STOCK CONTROL ARMS

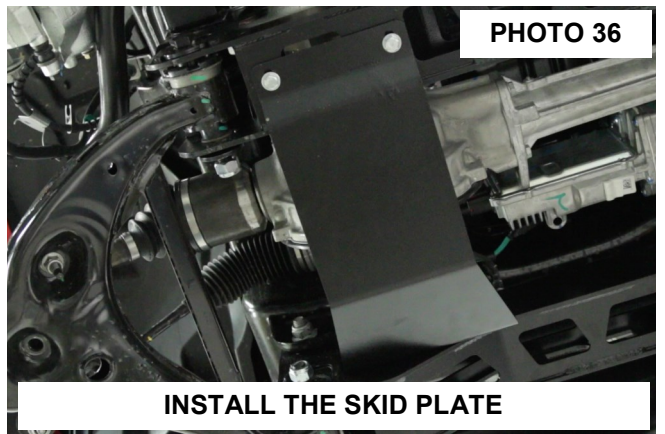

INSTALL THE SKID PLATE

46. Install the drive shaft spacer with supplied 10mm x 85mm hardware. **See Photo 37.** Torque to 35ft-lbs. using a 8mm allen.
47. Using a 10mm wrench remove the brake line bracket from the driver and pass side frame. **See Photo 38.**

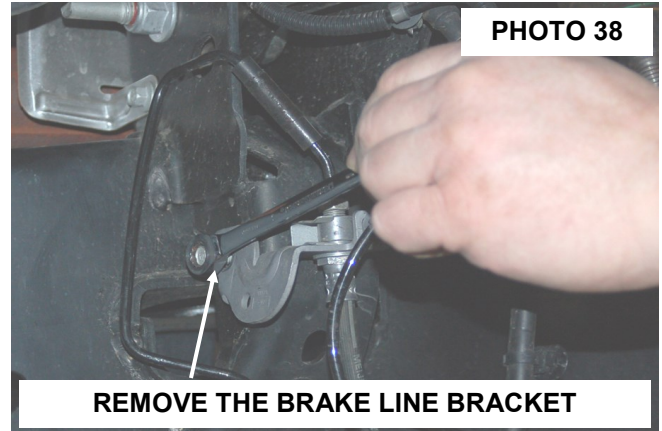
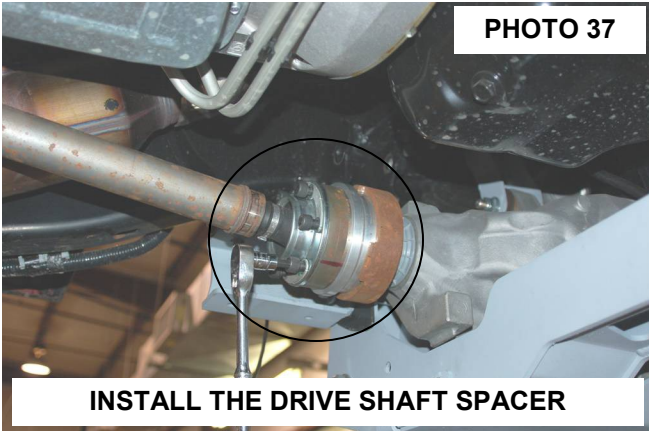

48. On the passenger side remove the brake line from the two factory clips. **See Photo 39.**
49. Install the new brake line bracket on the driver and passenger side with the stock hardware. **See Photo 40.**

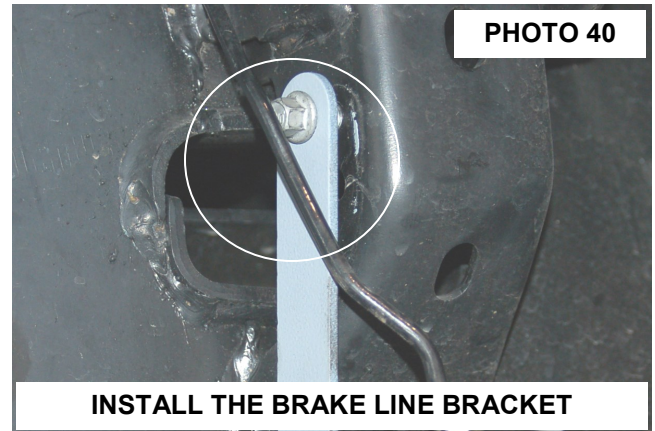
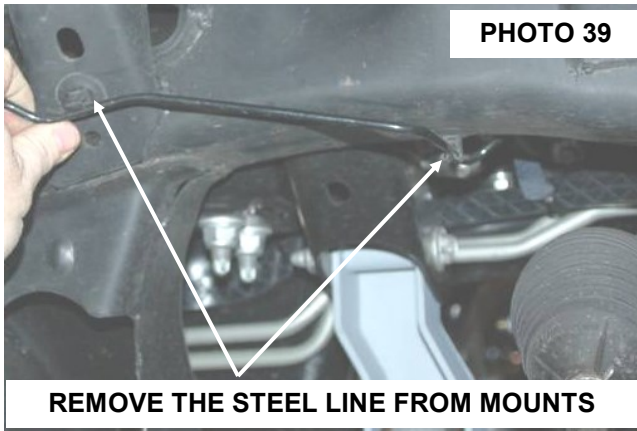

50. Install the factory passenger side brake line in the new bracket using the supplied 5/16" x 3/4" bolt, washer and nuts. **Take care to not kink the brake line. See Photo 41.**
51. On the driver side, pull slightly on the brake line to allow the line to be installed on the new bracket. Secure the brake line to the new bracket with the supplied 5/16" x 3/4" bolt, washers and nut. **Take care to not kink the brake line.**
52. Using a 13mm socket / wrench, torque the supplied brake line bolts to 15ft-lbs. Torque stock hardware to 18ft-lbs.

▲ NOTICE If installing new lifted struts or Vertex coil overs, follow supplied strut instructions and skip to step 56.

52. Install the supplied 10mm studs in the strut spacers with a 17mm wrench, using the 1/2" jam nut as a spacer. **See Photo 42.**

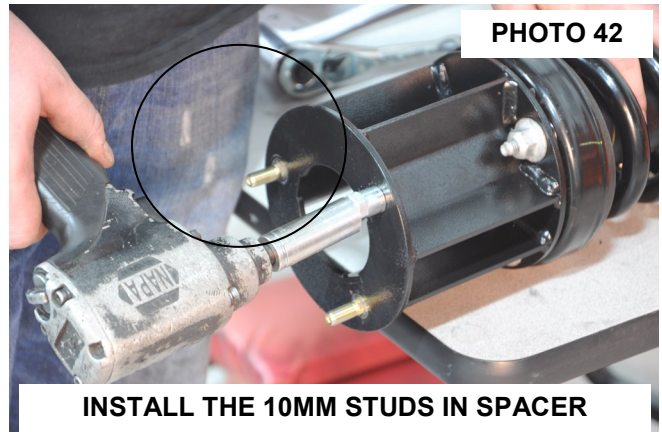
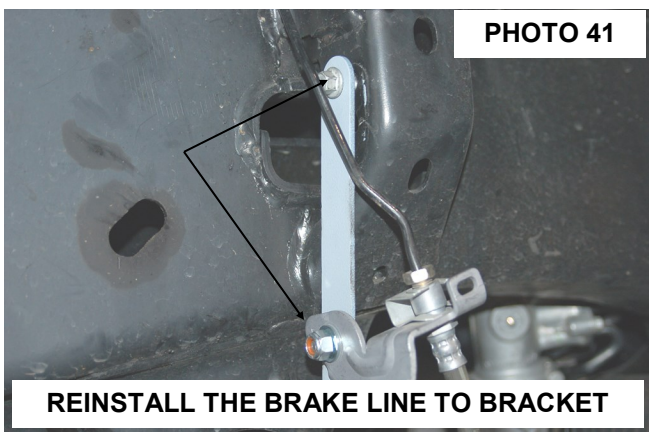

54. Using the stock hardware, install the strut spacers on the struts. Torque to 45ft-lbs. using a 15mm. **See Photo 43.**
55. Install the strut with strut spacers installed in the stock upper mount. Secure with supplied 10mm nuts, washers and lock washers. **See Photo 44.** Do not tighten at this time.

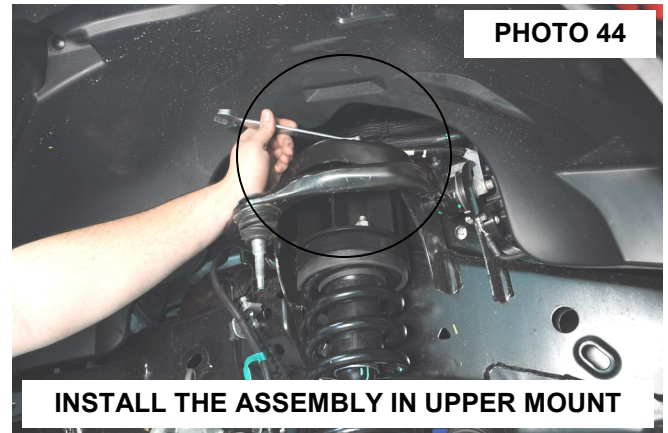
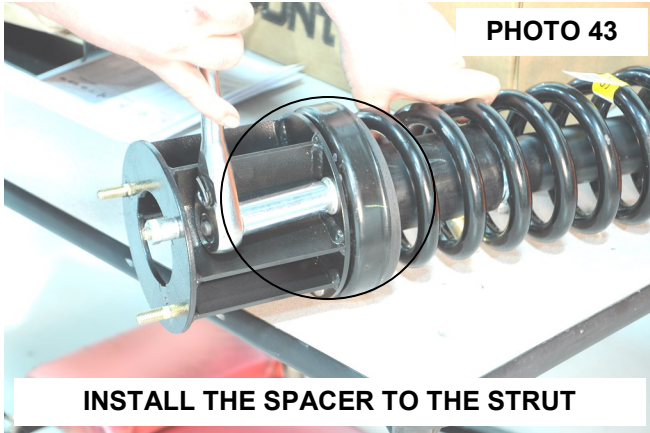

56. Install the lower strut in the lower control arm using the factory hardware. Torque using a 18mm socket.
57. Torque upper strut mount hardware using 17mm wrench.
58. Install the sway bar on the sway bar links located on the lower control arms. Install nut to hold the sway bar in place but do not tighten at this time. **See Photo 45.**
59. Swing up the sway bar and install on the sway bar drop brackets using the supplied 7/16" x 1" bolts, washers and nuts. Torque to 45ft-lbs. using a 5/8 wrench and socket. Torque the sway bar links to 18ft-lbs. using an 18mm socket. **See Photo 46.**

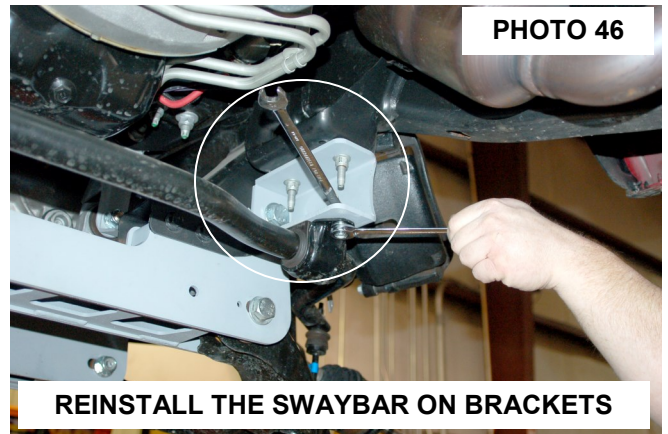
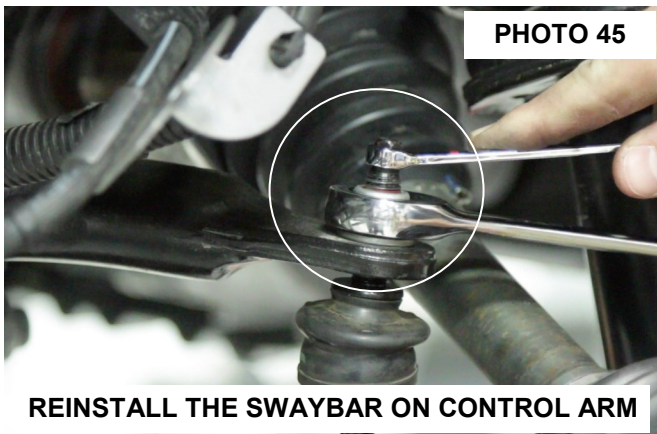

60. Remove the stock bearing assembly from the stock knuckle using a 18mm for the bearing and a 8mm for the locking hub mechanism. Install the bearing assembly on the lifted knuckle using the stock hardware. Torque to 160ft-lbs. using a 18mm wrench. **See Photo 47.**
61. Install the new knuckles using the stock hardware on the lower ball joints, tighten using 24mm and a 12mm wrench. **See Photo 48.** Final torque to 110ft-lbs. using a torque wrench. **Do not use air impact on the upper and lower ball joint, tighten with hand tools.**

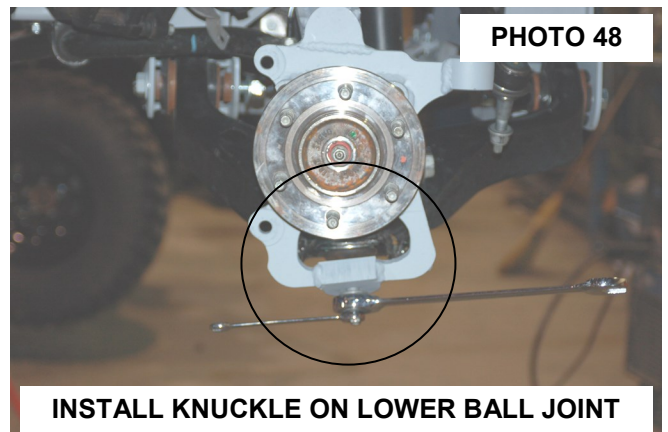
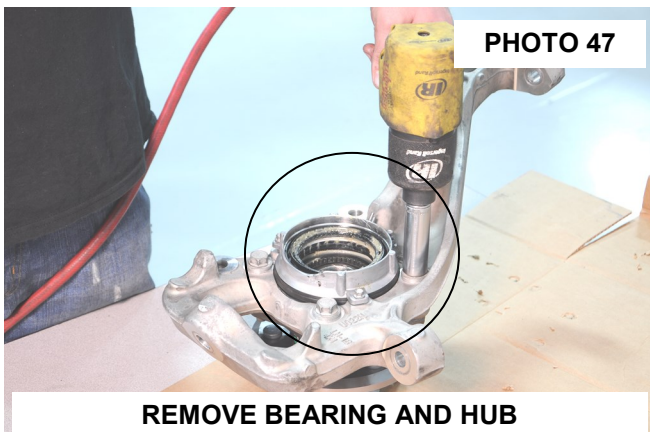

▲ NOTICE We recommend using OE instructions for disassembly and assembly of IWE actuator, the following instructions are for reference only.

62. Install IWE actuator on CV shaft.

▲ NOTICE Make sure the actuator splines line up to the splines on the CV shaft. See photo 49.

63. Install CV shaft into the knuckle assembly. See Photo 50.



64. Using a floor jack, raise the lower control arm and connect the upper ball joint on the upper control arm to the spindle. Tighten upper ball joint nut to the knuckle, use a 21mm wrench on the nut and a 10mm wrench on the ball joint stud. Final torque nut to 85ft-lbs. using a torque wrench.

65. Reinstall the outer tie rod to the knuckle, tighten nut using a 21mm wrench. Final torque nut to 60ft-lbs. using a torque wrench.

66. Using a hand vacuum pump, apply and hold 24inHG of vacuum to the actuator through the large port. See Photos 51 and 52.

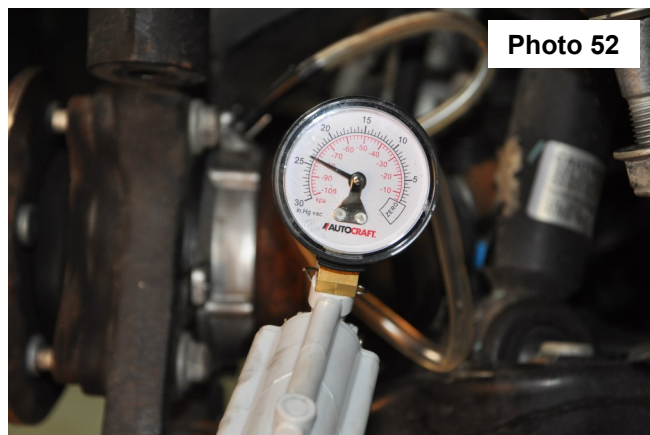
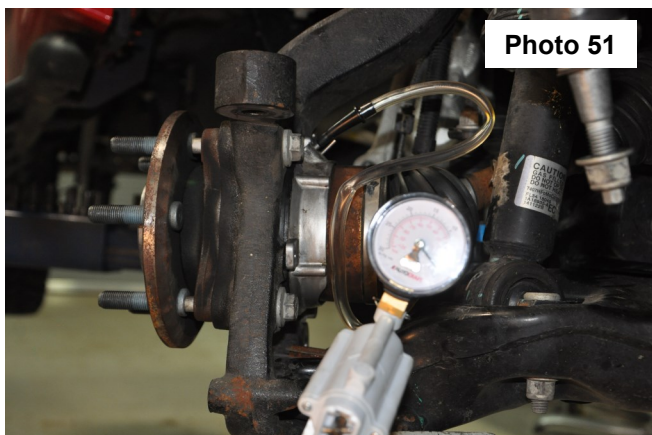

67. Install the (3) bolts securing the actuator to the knuckle, torque to 25ft-lbs. using an 8mm socket. **See Photo 53.**

▲ NOTICE 68.

With vacuum still applied to actuator. Measure the depth of the CV shaft treads protruding through the hub bearing. If **minimum 15.5mm or .61"** is not achieved, rotate the hub to eliminate binding of the splines. **See Photo 54.**

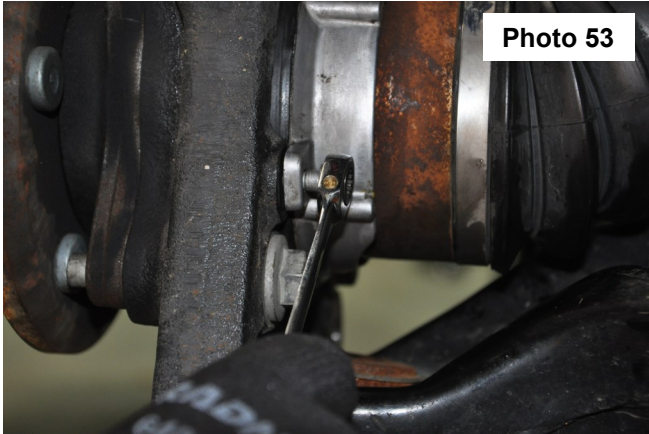

Photo 53

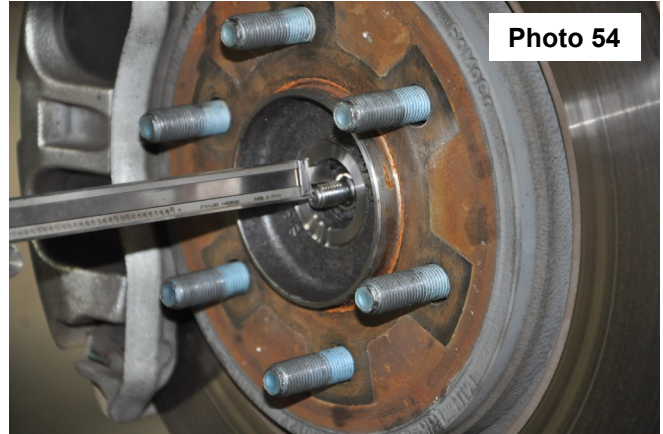

Photo 54

69. Install axle nut and torque to 30ft-lbs. **See Photo 55.**

▲ NOTICE

Do Not Use an impact, caution must be taken or damage to shaft may occur.

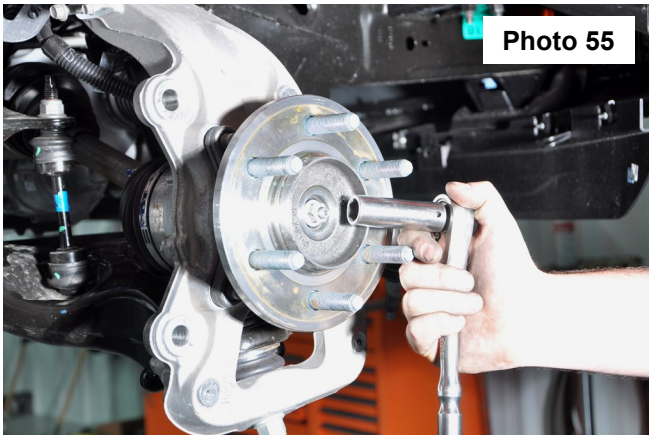

Photo 55

70. Verify free rotation of the hub with **NO** CV shaft rotation. No clicking or grinding noise should be present

71. Release the vacuum from the actuator and rotate the hub to engage the actuator. You may hear/feel the actuator engage.

72. Verify that the hub and CV rotate together. Reconnect the vacuum lines to the actuator. **See Photo 56.**

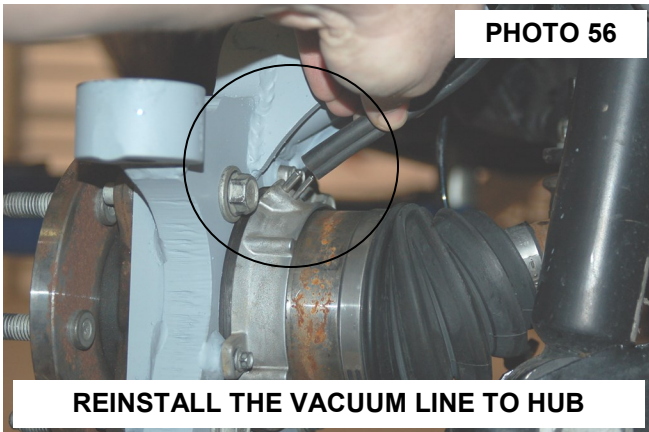
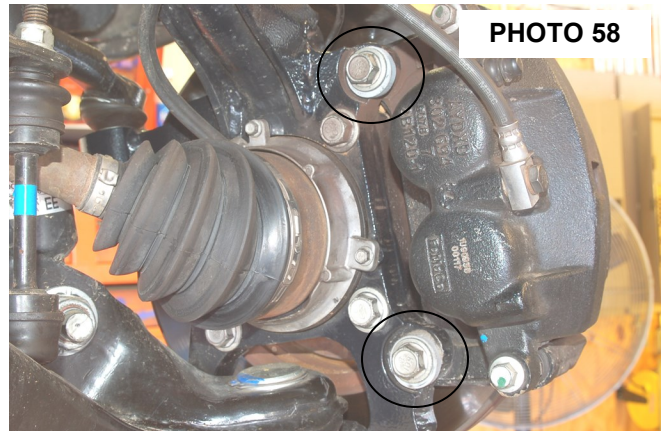
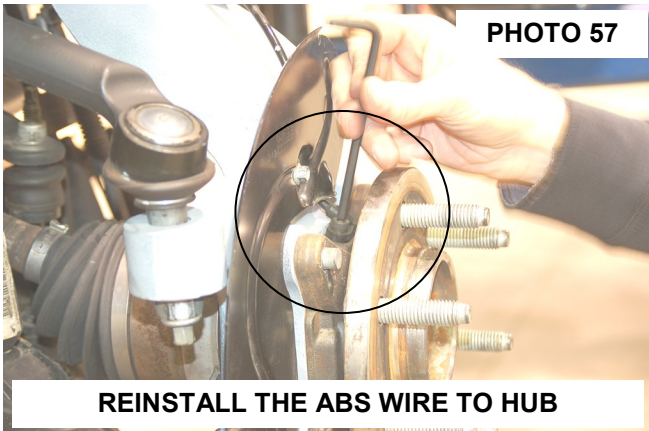

PHOTO 56

REINSTALL THE VACUUM LINE TO HUB

73. Install the ABS wire on the bearing assembly, torque to 8 ft-lbs. using a 5mm allen. **See Photo 57. Install the factory dust shield on the supplied knuckle, using factory hardware. torque to 14ft-lbs. use a 8mm socket.**
74. Install the rotor and caliper on the knuckle with the stock hardware, Torque to 140ft-lbs. using a 21mm socket and torque wrench. **See Photo 58.**



75. Make sure the vacuum hose and ABS wire are out of harms way. Using the supplied zip tie, secure the vacuum hose and ABS wire to the knuckle neck.
76. Install the tires and wheels using a 21mm socket. Remove the jack stands and lower the truck to the ground.
77. Tighten the lower control arm bolts using a 1-1/16" wrench and socket. **Torque to 240 ft/lbs.**

REAR INSTALLATION

1. Chock the front tires and jack the rear the rear end up. Put jack stand under the frame rail and lower truck onto jack stands.
2. Remove tires and wheels using a 21mm socket.
3. Remove rear shocks from the upper and lower mount using 18mm and a 15mm wrench. **See Photo 1 & 2.** Retain the stock hardware.

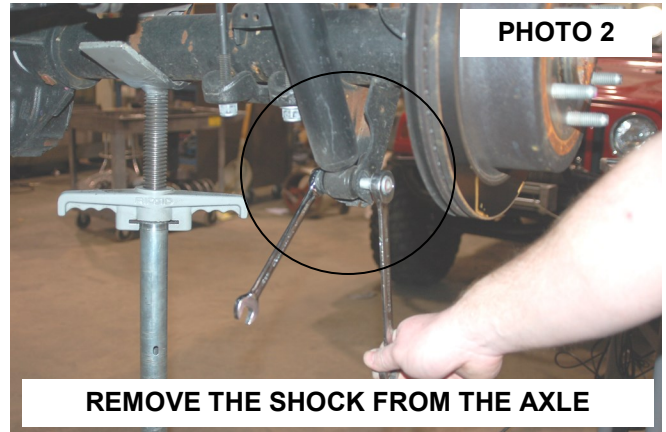
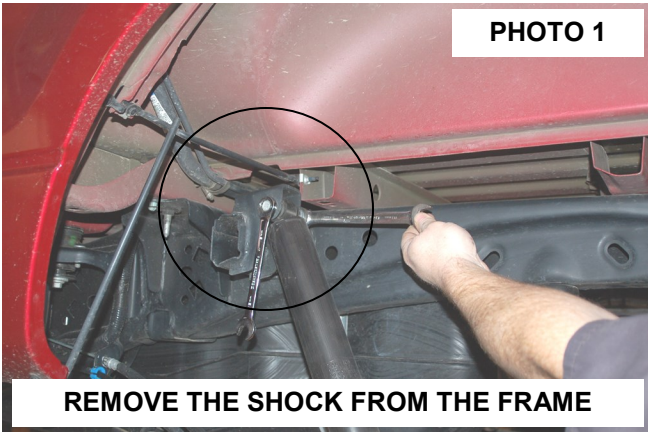

4. Using a 10mm wrench, remove the brake line assembly on the inner driver side frame rail. **See Photo 3.**
5. Install the brake line assembly to the new bracket using the supplied 3/8" x 1" bolt, washers and nut. Torque to 30ft-lbs. using a 9/16" socket and wrench. **See Photo 4.**
6. Install the brake line extension bracket on the frame using the stock hardware and torque to 18ft-lbs. using a 10mm socket. **See Photo 4.**

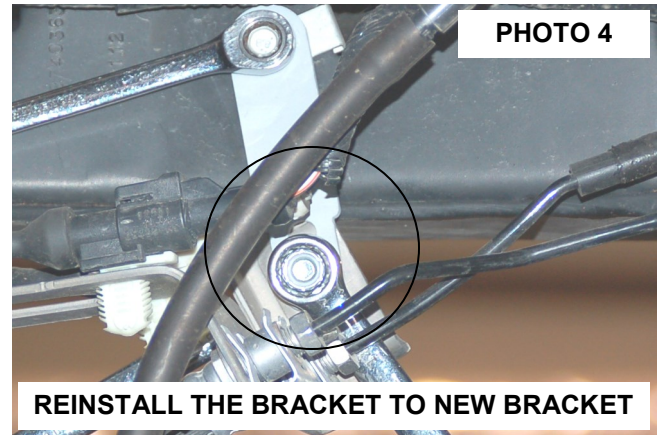
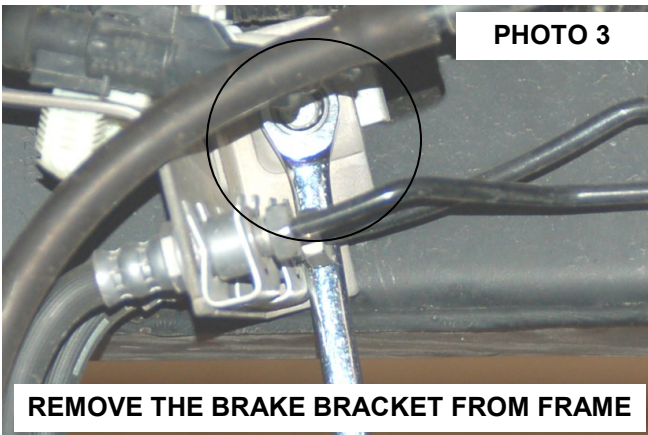

7. Remove the e-brake cable mount with a 10mm wrench as shown on the drivers side as shown in **Photo 5.**
8. Install the supplied e-brake bracket with the factory hardware. Torque to 10ft-lbs. use a 18mm wrench. **See Photo 6.**

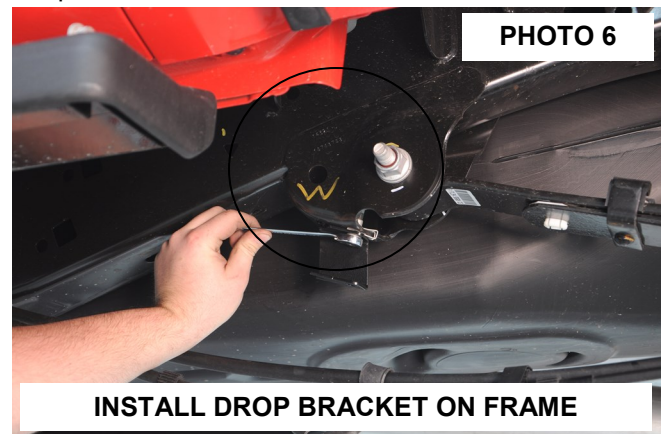
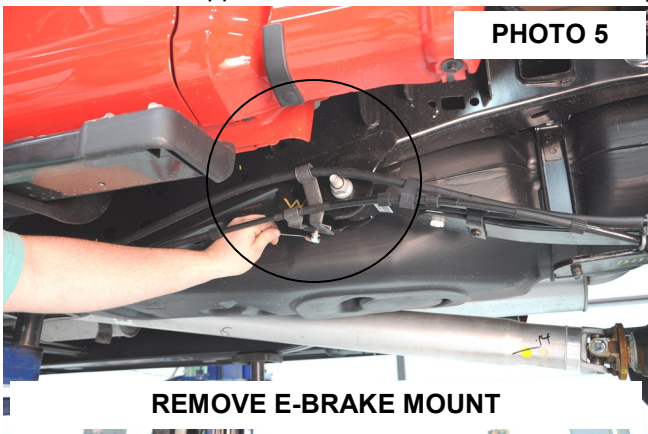

9. If equipped install the e-brake cable mount to the new e-brake drop bracket using the supplied 5/16" bolt, washers, and lock nut, torque to 15ft-lbs. using a 1/2" wrench and socket. **See Photo 7.**
10. Using a jack support the rear end and remove U-bolts using a 21mm socket and remove the factory blocks. **Retain factory block for the 4" kit. See Photo 8.**

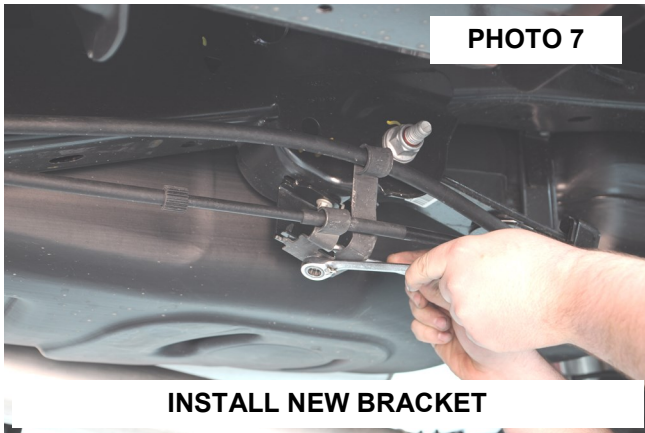

PHOTO 7

INSTALL NEW BRACKET

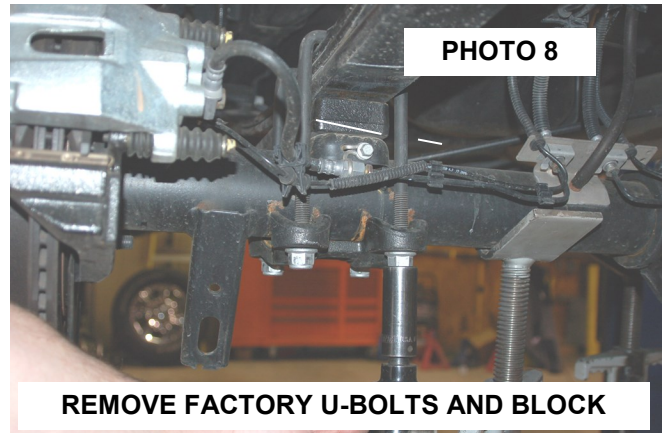

PHOTO 8

REMOVE FACTORY U-BOLTS AND BLOCK

11. Install the supplied blocks on the block pin holes on the axle and raise the axle into place. **See Photo 9.**
NOTE: The 4" kit will have a standard block with the factory block while the 5"/6" kit will use the Rough Country Anti-wrap design blocks. **Note- Taller end of block to the rear of the truck!**
12. Install the axle u-bolts, torque to 90ft-lbs. using a 22mm socket.
13. For the 5"/6" kits install Anti-wrap u-bolts over the leaf spring and into the blocks. Secure with supplied hardware and torque to 45ft-lbs. using a 16mm socket. **See Photo 10.**

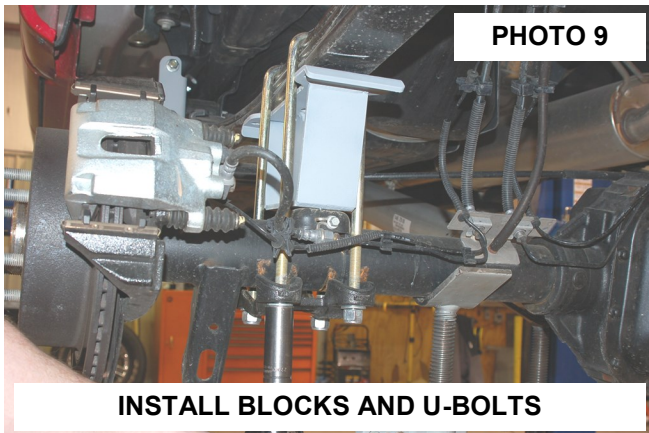

PHOTO 9

INSTALL BLOCKS AND U-BOLTS



PHOTO 10

7/16"

9/16"

14. **NOTE: 6" Kit Only.** Install the supplied rear bump stop bracket, with the supplied 3/8" x 3.5" round u-bolt, and 3/8" nylock nuts, making sure the bracket lines up with the factory bump stop. Torque to 30ft-lbs. with a 9/16" socket. **See Photo 11.**

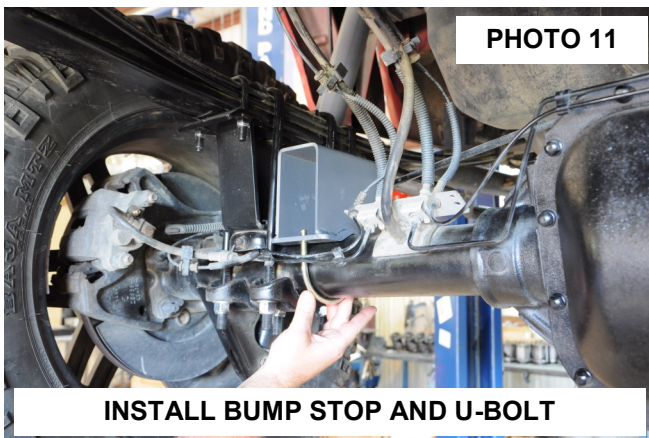

PHOTO 11

INSTALL BUMP STOP AND U-BOLT

15. For V2 rear shocks and Vertex rear shocks follow shock installation instructions included in shock package and skip to step 17.
16. Install the new shock absorbers in the upper and lower mounts using the stock hardware. Torque to 55ft-lbs. using a 18 and 15mm wrench. **N3 shocks will mount with the body down.**
17. Install the rear tire and wheels.
18. Raise up the rear of the vehicle and remove the jack stands. Lower the vehicle to the ground.



CUTTING / DRILLING TEMPLATE—FR SIDE OF DRIVER CROSSMEMBER

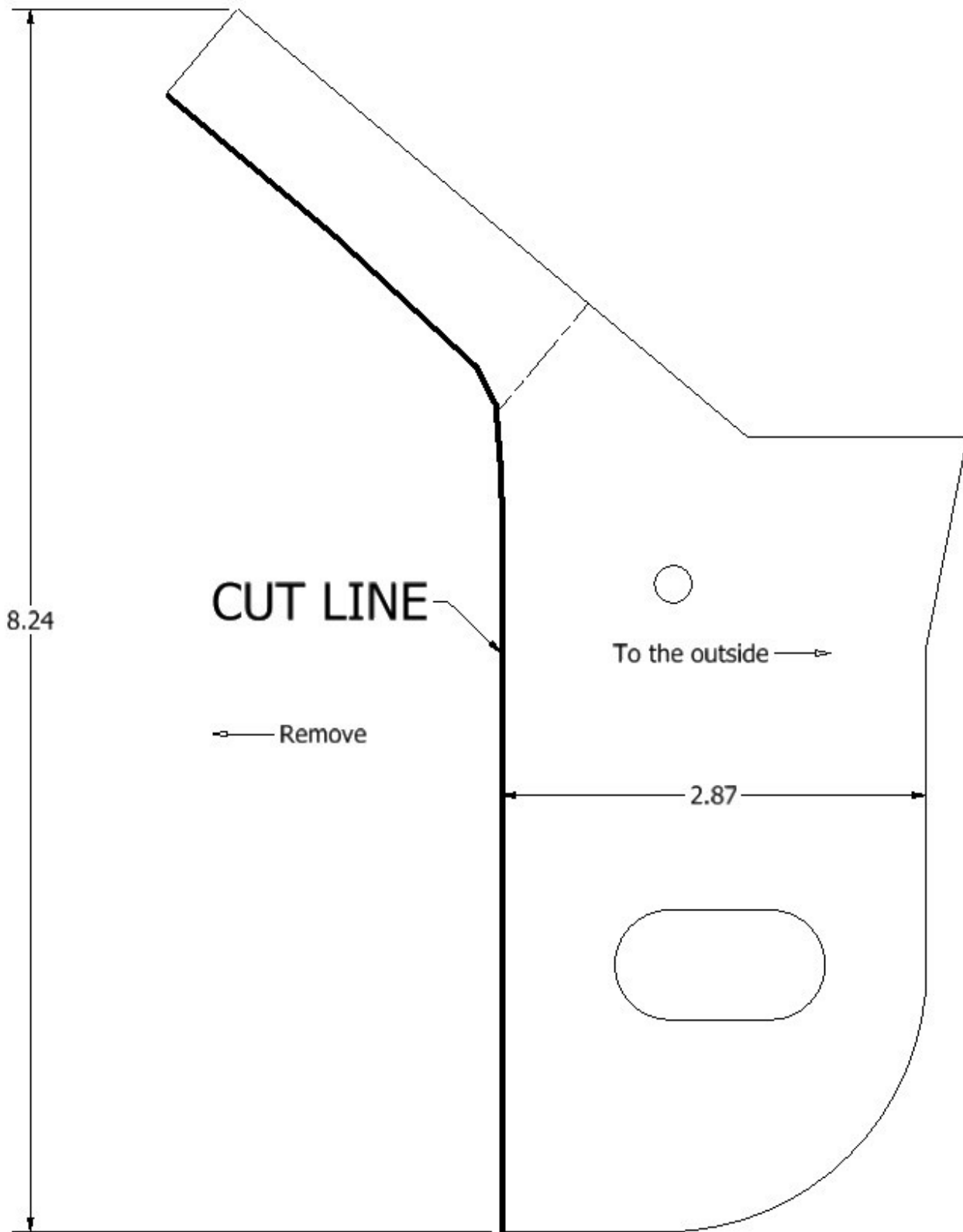

CUTTING / DRILLING TEMPLATE—REAR OF DRIVER SIDE CROSSMEMBER

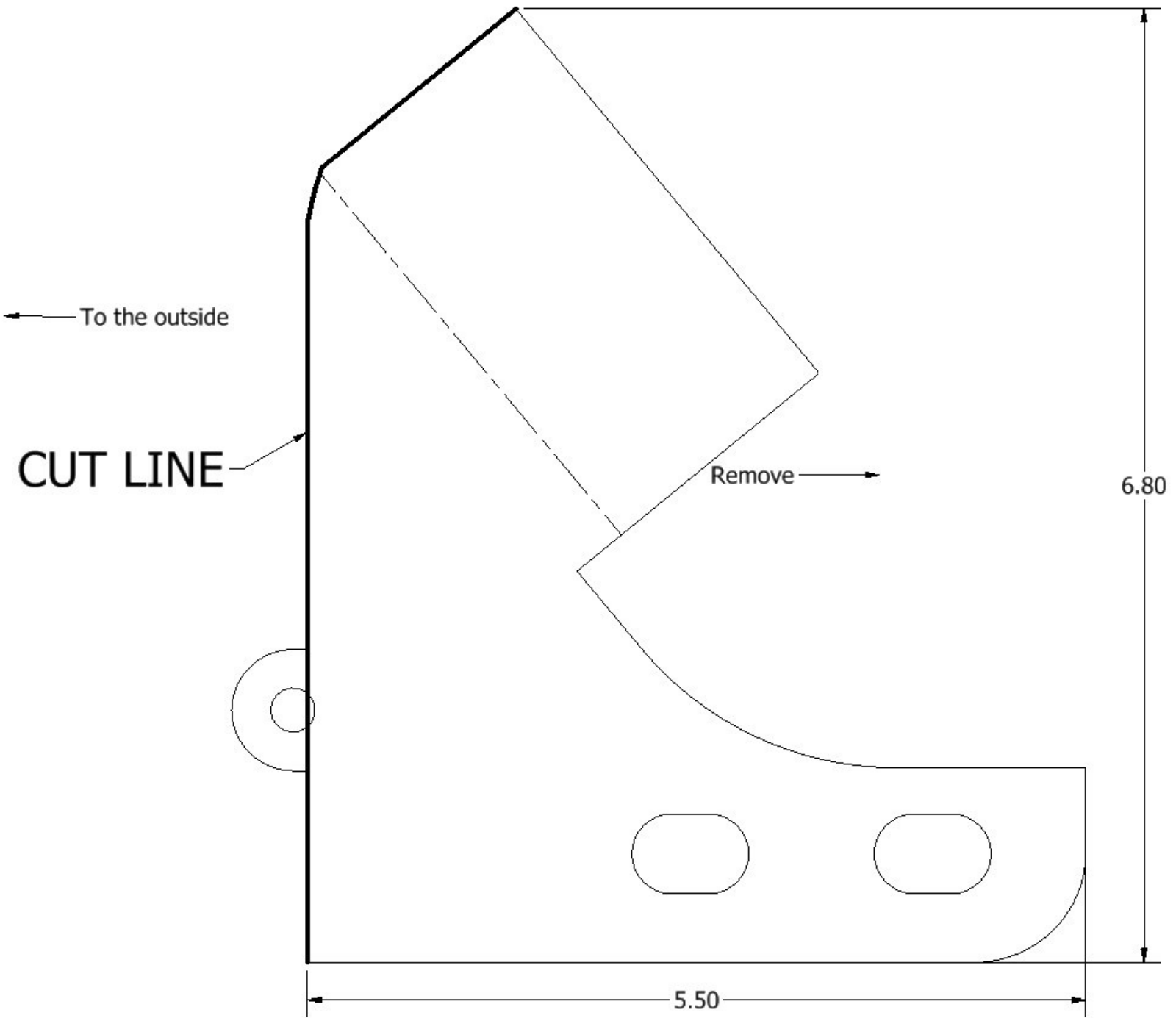

POST INSTALLATION INSTRUCTIONS

1. Check all fasteners for proper torque. Check to ensure there is adequate clearance between all rotating, mobile, fixed and heated members. Check steering gear for interference and proper working order. Test brake system
2. Perform steering sweep. Check to ensure brake hoses have sufficient slack and will not contact rotating, mobile, or fixed members, adjust lines/brackets to eliminate interference and maintain proper working order. Failure to perform inspections may result in component failure
3. Readjust headlights to factory settings
4. Have vehicle aligned by a certified alignment professional.
5. Re-torque all nuts, bolts, and especially u-bolts after the first 100 miles, again after another 100 miles and then check periodically thereafter
6. All components must be retightened after 500 miles, and every three thousand miles after installation.

Thank you for purchasing a Rough Country Suspension System.

By purchasing any item sold by Rough Country, LLC, the buyer expressly warrants that he/she is in compliance with all applicable , State, and Local laws and regulations regarding the purchase, ownership, and use of the item. It shall be the buyers responsibility to comply with all Federal, State and Local laws governing the sales of any items listed, illustrated or sold. The buyer expressly agrees to indemnify and hold harmless Rough Country, LLC for all claims resulting directly or indirectly from the purchase, ownership, or use of the items.



